

40096

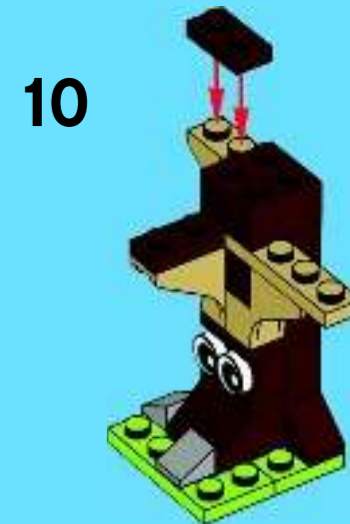

6065066

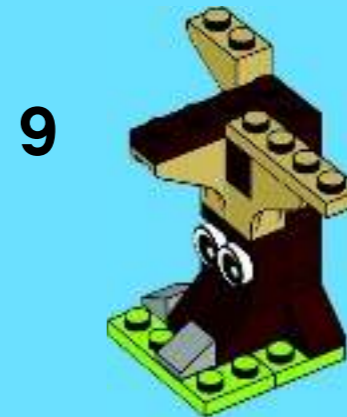
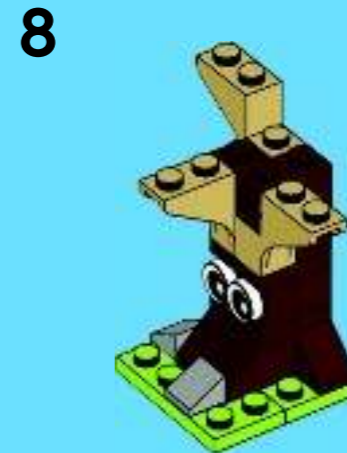
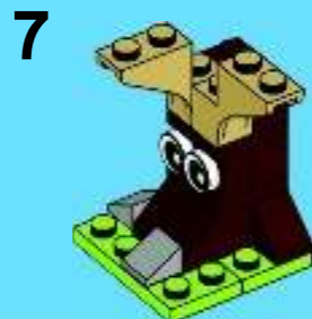
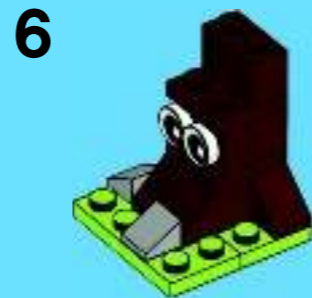
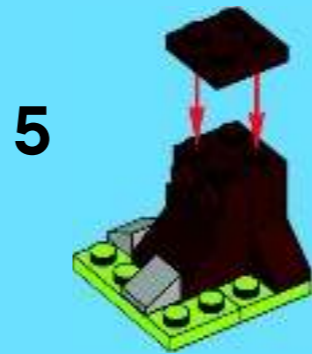
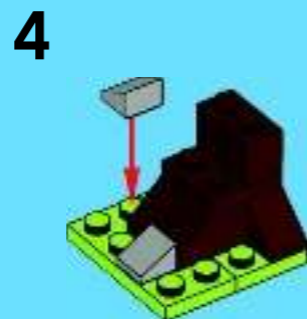
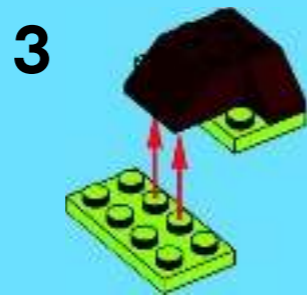

Warning! Choking hazard. Small parts.
 Achtung! Erstickungsgefahr. Kleinteile.
 Attention ! Risque d'étouffement. Petites pièces.
 Avvertenza! Pericolo di soffocamento. Parti piccole.
 Waarschuwing! Verstikkingsgevaar. Kleine deeltjes.
 Advertencia! Riesgo de asfixia. Piezas pequeñas.
 Advarsel! Kvælningsfare. Små dele.
 Varoitus! Tukehtumisvaara. Pieniä osia.
 Varning! Kvävningrisk. Små delar.
 Atenção! Perigo de asfixia. Peças pequenas.
 Προειδοποίηση! Κίνδυνος πνιγμού. Μικρά κομμάτια.
 警告! 窒息の危険性。小さな部品。
 警告! 小心窒息。当心小物件。
 경고! 질식 위험. 작은 부품 포함.
 Внимание! Риск удушья. Мелкие детали.

Ostrzeżenie! Zagrożenie zadławieniem. Małe elementy.
 Upozornění! Nebezpečí udušení. Malé součástky.
 Upozornenie! Nebezpečenstvo udusenja. Malé súčasti.
 Figyelmeztetés! Fulladásveszély! Kis elemek.
 Обережно! Ризик задухи. Дрібні деталі.
 Upozorenje! Opasnost od gušenja. Sitni dijelovi.
 Упозорење! Опасност од гушења. Мали делови.
 Opozorilo! Nevarnost zadušitve. Majhni delčki.
 Avertisment! Pericol de sufocare. Piese mici.
 Внимание! Опасност от задавяне. Малки части.
 Brīdinājums! Aizrīšanās risks. Sīkas daļas.
 Hoiatus! Lõmbumisohut. Väiksed osad.
 Jspèjimas! Uždusimo pavojus! Mažos detalės.
 Dikkat! Boğulma tehlikesi. Küçük parçalar.



12

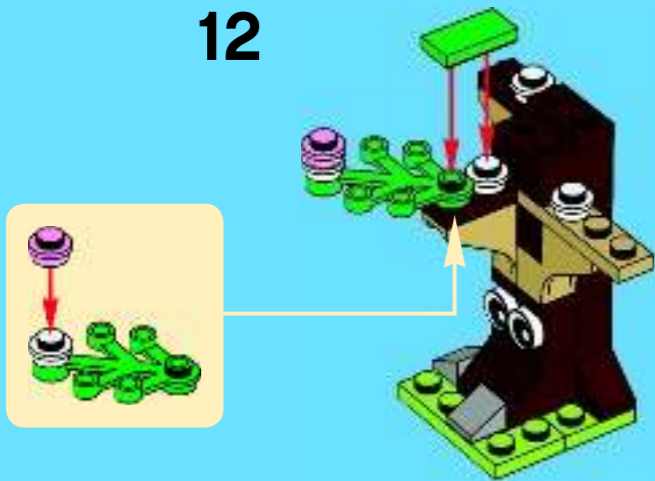

13

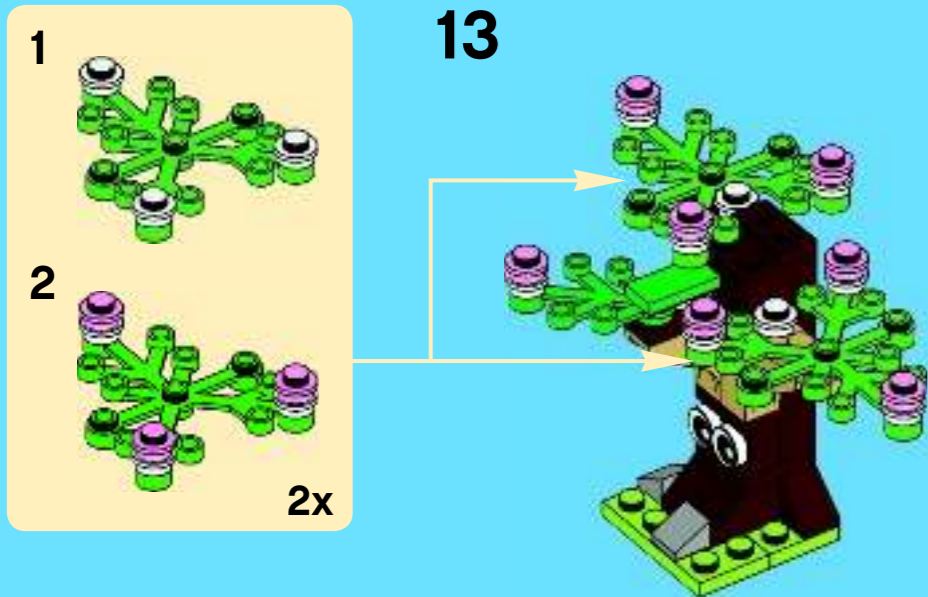

14



15



16

