



Ages/edades

6+

40213



6149726 / 6149727

Warning! Choking hazard. Small parts.
 Achtung! Erstickungsgefahr. Kleine Teile.
 Attention ! Danger d'étouffement. Petits éléments.
 Avvertenza! Rischio di soffocamento. Piccole parti.
 Waarschuwing! Verstikkingsgevaar. Kleine onderdelen.
 ¡Advertencia! Peligro de atragantamiento. Partes pequeñas.
 Advarsel! Kvælningsfare. Små dele.
 Viðvörðun! Köfnunarhætta. Litill hlutir.
 Varoitus! Tukehtumisvaara. Pieniä osia.
 Varning! Kvävningrisk. Små delar.
 Advarsel! Kvelningsfare. Små deler.
 Atenção! Risco de asfixia. Pequenas partes.
 Προειδοποίηση! Κίνδυνος πνιγμού. Μικρά μέρη.
 警告! 窒息の危険性。小さな部品。
 警告! 小心窒息。当心小物件。
 경고! 질식 위험. 작은 부품 포함.
 Внимание! Риск удушения. Мелкие детали.
 Ostrzeżenie! Niebezpieczeństwo udławienia się. Małe części.
 Upozornění! Nebezpečí zalknutí. Malé části.
 Upozornenie! Nebezpečenstvo dusenia. Malé časti.
 Figyelmeztetés! Fulladásveszély. Kis alkatrészek.
 Обережно! Ризик задухи. Дрібні деталі.
 Uprozorenje! Opasnost od gušenja. Mali dijelovi.
 Упозорење! Опасност од гушења. Мали делови.
 Предупредување! Опасност од задушување. Мали делови.
 Oporozilo! Nevarnost zadušitve zaradi tujka. Majhni deli.
 Avertisment! Pericol de sufocare internă. Părți mici.
 Внимание! Опасност от задавяне. Малки части.
 Brīdinājums! Aizrīšanās risks. Sīkas detaļas.
 Hoiatus! Kägistamisoho. Väikesed osad.
 Ispéjimas! Pavojus užspringti. Smulkios detalės.
 Uyarı! Boğulma Tehlikesi (Havasızlıktan). Küçük Parçalar.
 تحذیر! خطر الاختناق. أجزاء صغيرة

1

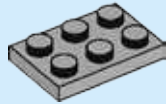

2

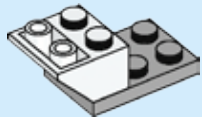

3

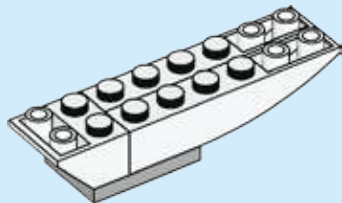

4

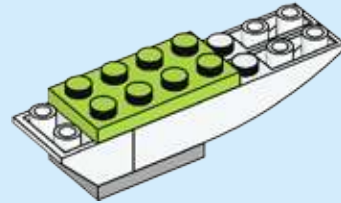

5

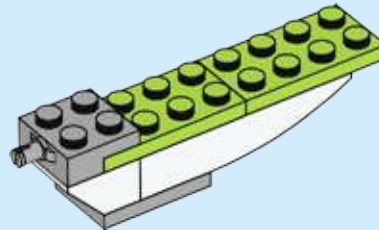

6

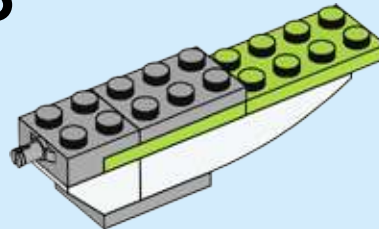

7

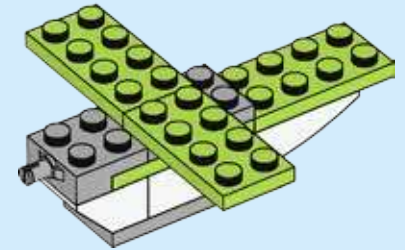

8

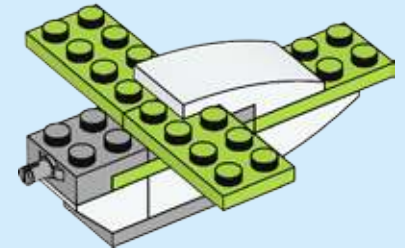

9

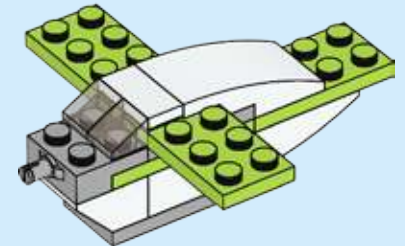

10

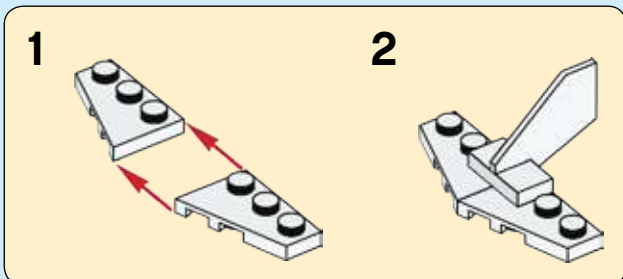
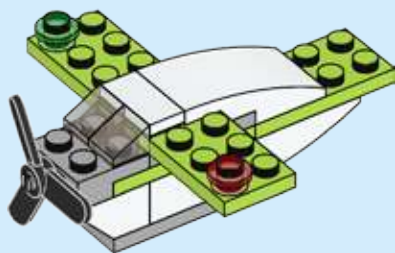

11

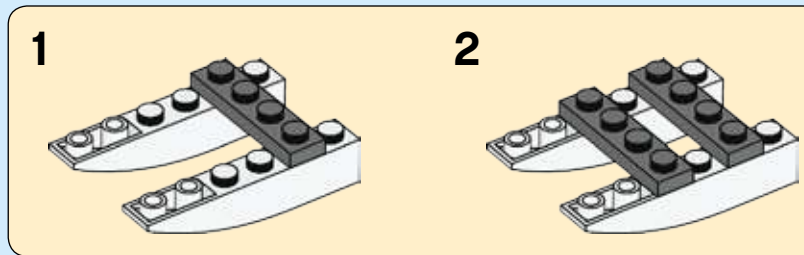
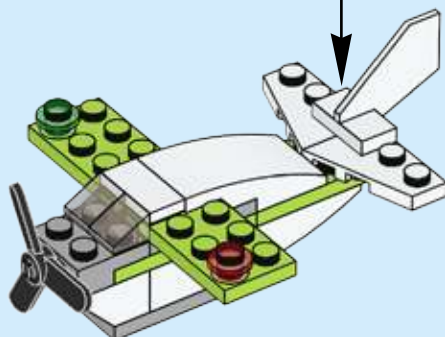

12

